



# SHOWER SCREEN COLLECTION



SEMI-FRAMELESS | FRAMELESS | SLIDING | BATH SCREENS | FREE-STANDING  
CUSTOM DESIGNS | MIRRORS | CURVED SLIDING | SHOWER HARDWARE | PANELS

# SHOWER SCREEN MEASURING GUIDE

## 1. MEASURE YOUR SHOWER AREA

Only after you have completed installing your shower base, plumbing and tiling you will be able to measure the exact area ready for the shower screens, measure either:

Option 1 - measure base from internal recess

Option 2 - measure tiles from wall to wall

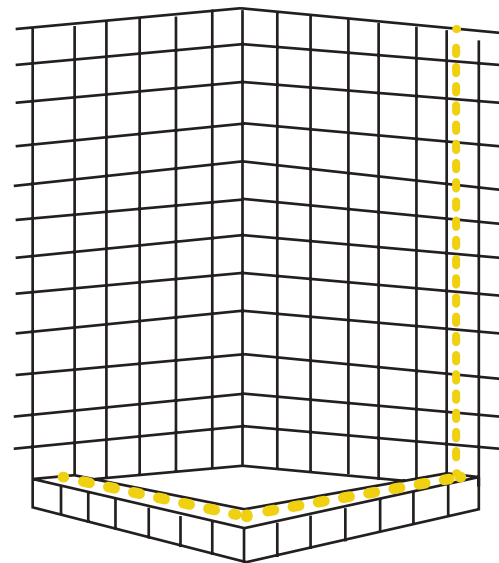
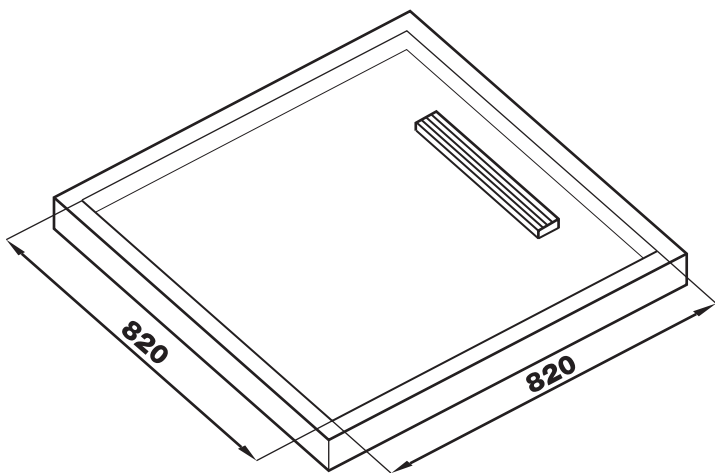

Now you will have your front door width and return panel width.

Some of PIPERS Showers have standard heights either 1850, 1900, 2000 or custom made sizes.

## 3. YOU ARE NOW READY TO

Use a spirit level to check if walls & base are square, please show this on your order drawings.

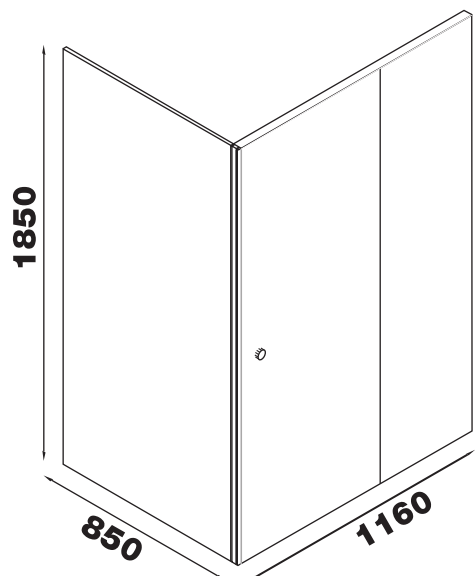

## TOOLS CHECKLIST:

What you may need in your tool box for DIY installation TOOLS & Material Checklist

NEUTRAL CURE SILICONE  
LEVEL  
POWER DRILL

PENCIL  
SILICONE GUN  
ALL TOOLS AVAILABLE AT YOUR NEAREST  
HARDWARE STORE

TAPE MEASURE  
6.0 MM MASONRY DRILL BITS

# ABOUT US

From the stunning landscape of country Australia to trendy Hong Kong, Pipers design team draw on inspiration from global organic and architectural elements to design world leading showers and bathroom product here in Australia.

Positioned in the Melbourne Campbellfield precinct PIPERS is on the doorstep to scour the world for best practice in manufacturing and design.

Run by a family owned company delivering cutting edge bathroom products, shower screens, glass splashbacks, wardrobes, mirrors, shower bases, glass, hardware and aluminium products.

Pipers customer service is dedicated to giving you service and design advice with a strong focus around personalising your project experience. Our experienced team are standing by managed with experience in manufacturing, in home services and importing. Our team are passionate about combining design with technically high functioning goods to transform your interior and lifestyle.

Our manufacturing plant incorporates state of the art machinery together with high grade raw materials to deliver you the finest product in a quality controlled environment.

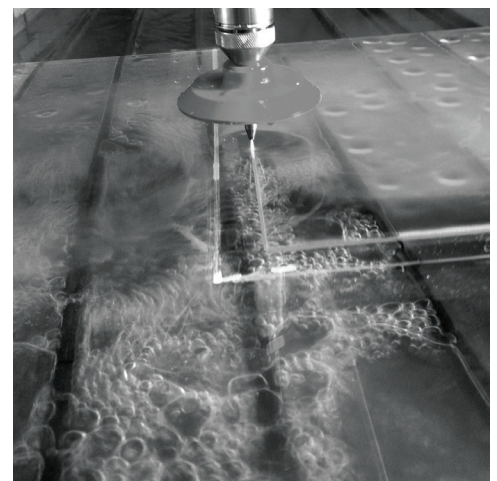

# ELFREDA SUITE SEMI-FRAMELESS SHOWER SCREEN SUITE





FRONT ONLY



FRONT AND RETURN

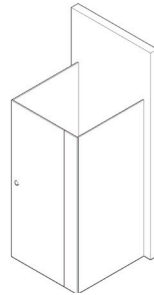

FRONT & 2 SIDES 90 DEGREE

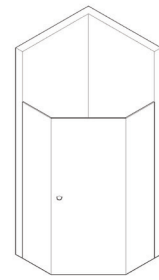

FRONT & 2 SIDES 45 DEGREE

## TECHNICAL:

- Magnetic closure strip on the door
- Clear safety glass
- Fully reversible for left or right hand entry
- 60mm adjustment on the door
- Suitable for placing on tiles or a base
- Available in a large range of sizes and configurations

## SPECIFICATIONS:

### Sizes:

- 1850mm Height or 2000mm Height
- + Front Door Widths – 560mm – 1580mm (any size in between)
- Larger custom front doors available with PIPERS fixed panel joiners.
- + Return Panel – all sizes available standard and custom made

### Standard Shower screen size guide for shower bases:

- Front door x Return panel
- 740-800mm x 765mm to suit 800 x 800 or 820 x 820 base
- 800-860mm x 825mm to suit 900 x 900 base
- 980-1040mm x 960mm to suit 1000 x 1000 base
- 800-860mm x 340mm x 340mm to suit 1000 x 1000 diamond/bay shower base
- 1100-1160mm x 825mm to suit 1200 x 900 base
- 1160 - 1220mm x 860mm to suit 1200 x 900 tiled area.

Tip: For a 900 x 900mm tiled area a 860-920mm x 860mm screen is suitable.

Above sizes are a guide only, sizes can vary with tile & base installation. Please provide your drawings/measurements in mm.

## FEATURES:

- Semi-frameless shower suite
- Round Knob handle
- Slimline contemporary frame
- Elegant structure in your bathroom
- Functional and flexible in design
- Easy to install
- Waterseal on the door
- Chrome plated capping
- Frameless pivot door

Shower doors are ready assembled in the box – simple install the return panel and lift in the door!

## COLOUR:

Polished chrome, matte black available in selected sizes

To order – simply provide your internal base area measurements as on page 2 – the adjustment in this screen means we only require your internal base measurements where the shower sits & we make all the necessary deductions.

## OVER 70 SIZES!



Magnetic water tight closure strip & waterseal



Pivot hinge, frameless door, telescopic adjustment



Front only configuration

# MAZE WALK-IN SHOWER SUITE

## FEATURES:

- Frameless Walk in Shower
- Slimline contemporary frame for stability
- Frameless clear safety glass
- Fully reversible for left or right hand entry
- Adjustable design
- Easy to install configuration
- Suitable for placing on tiles or a base
- 8 mm toughened safety glass

## BENEFITS:

- Easy to maintain
- Architectural design
- Luxurious size

## COLOUR:

Polished chrome

## SPECIFICATIONS:

### Sizes:

1900mm Height

1440mm Width x 845mm return panel

\*Grate not included



# MATTE BLACK SEMI-FRAMELESS SHOWER SCREEN SUITE

## TECHNICAL:

- Magnetic closure strip on the door
- Clear safety glass
- Fully reversible for left or right hand entry
- 60mm adjustment on the door
- Suitable for placing on tiles or a base
- Available in a large range of sizes and configurations
- 1950mm Height
- 680mm width - 1580mm widths available

## SPECIFICATIONS:

- 1950mm Height
- 680mm width - 1580mm widths available
- Available in a large range of sizes and configurations

## FEATURES:

- Semi-frameless shower suite
- Round Knob handle
- Slimline contemporary frame
- Elegant structure in your bathroom
- Functional and flexible in design
- Easy to install
- Waterseal on the door
- Frameless pivot door

Shower doors are ready assembled in the box – simple install the return panel and lift in the door!

FRONT ONLY AVAILABLE!



# PIPERS FRAMELESS

## FEATURES:

- Frameless Shower Screen
- Dual action hinge opening inwards and outward
- Durable hinges, manufactured in brass
- Several handle options
- Luxury seamless finish

## TECHNICAL:

- Manufactured to exact measurements
- Suitable for placing on tiles or a base
- 10 mm toughened safety glass
- See page 24-25 for hardware

## SPECIFICATIONS:

Sizes:  
 2100mm Height or custom made available.  
 Screens suitable for  
 900mm x 900mm base / tiles  
 1000mm x 1000mm base / tiles  
 1200mm x 900mm base / tiles

Other sizes available by custom made order.

This design is custom made, made to order available as supply only or installed by a professional.

## COLOURS:

- Polished chrome
- Matte Black
- Brushed Nickel
- Brushed Brass
- Gun Metal Grey
- Other upon request
- Clear 10mm glass or other glass

## TIP:

Glass is precious, it doesn't bend, and you can't change it once its toughened safety glass. Take care in providing measurements for custom made sizes.

\*Other configurations available



FRONT



FRONT AND RETURN



FRONT & 2 SIDES 90 DEGREE



FRONT & 2 SIDES 45 DEGREE

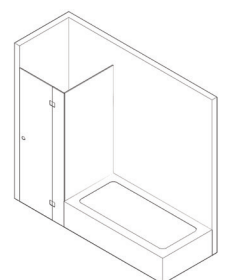

FRONT AND HOB



## STANDARD KITS AVAILABLE

### Standard Hardware Includes:

- 2 x 180 degree glass to glass hinges (H-GG180 SQ C)
- 4 x glass fix brackets square (H-GFB10 SQ)
- Knob Handle Round (H-KHRD)
- Under door waterseal
- Glass Panels & top gusset

Other hardware colours on request.

### Front and Return Kits

- 800 x 800 x 2100H (180 infill, 600 door, 800 panel)
- 850 x 850 x 2100H for 900 base (240 infill, 600 door, 850 panel)
- 900 x 900 x 2100H (230 infill, 650 door, 900 panel)
- 1000 x 1000 x 2100H (330 infill, 650 door, 1000 panel)
- 1160 x 850 x 2100H for 1200 base (490 infill, 650 door, 850 panel)
- 1200 x 900 x 2100H (530 infill, 650 door, 900 panel)
- 1200 x 900 x 2100H (265 infill, 650 door, 265 infill, 900 panel)
- 1230 x 900 x 2100H (280 infill, 650 door, 280 infill, 900 panel)



Front only hinged off the wall Frameless Suite with 10mm clear Australian Safety Glass

### Front Only Kits

- 850 (240 infill, 600 door) for 900 base
- 900 (240 infill, 650 door)
- 1150 (490 infill, 650 door ) for 1200 x 900 base
- 1190 (530 infill, 650 door)
- 1200 (270 infill, 650 door, 270 infill)

Custom made in any size available to order.





# FRAMELESS FIXED PANEL SHOWER SCREEN

## FEATURES:

- Frameless glass panel
- Brass hardware fittings or Aluminium Channel
- Easy to install configuration
- Suitable for placing on tiles or a base
- Create a minimalist feature in your bathroom
- 10mm toughened safety glass
- Australian Standards Guaranteed
- Optional Support Brace upon request

## CONFIGURATIONS:

Option 1  
Glass with Bracket

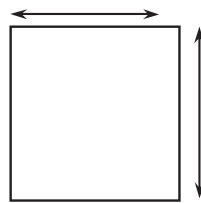

Use with hardware  
H-GFB10 SQ/RD

Option 2  
Glass with glazing channel

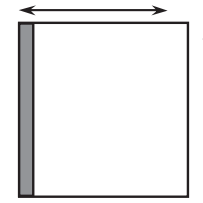

Use with hardware  
H-GCH-10

## SPECIFICATIONS:

- 600mm W x 200mm H
- 800mm W x 2100mm H
- 850mm W x 2100mm H
- 860mm W x 2100mm H
- 870mm W x 2100mm H
- 880mm W x 2100mm H
- 890mm W x 2100mm H
- 900mm W x 2100mm H
- 910mm W x 2100mm H
- 920mm W x 2100mm H
- 930mm W x 2100mm H
- 940mm W x 2100mm H
- 950mm W x 2100mm H
- 960mm W x 2100mm H
- 970mm W x 2100mm H
- 980mm W x 2100mm H
- 990mm W x 2100mm H
- 1000mm W x 2100mm H
- 1050mm W x 2100mm H
- 1100mm W x 2100mm H
- 1150mm W x 2100mm H
- 1200mm W x 2100mm H
- 1300mm W x 2100mm H
- 1400mm W x 2100mm H
- 1500mm W x 2100mm H

More sizes available  
custom manufactured  
in any size!



# CUSTOM SHOWER SCREENS DESIGNS



Contact our project team to discuss  
your custom design shower screen  
today!

# DOME SLIDING CIRCULAR SHOWER SCREEN

## FEATURES & BENEFITS:

- French door sliding action
- Smooth running roller bearing
- Easy slot & lock installation
- Elegant F style handle design
- Space saving curve

## SPECIFICATIONS:

Sizes:  
1900 x 900 x 900 base

## TECHNICAL:

- Magnetic closure strip on the door
- 6mm toughened safety glass
- Shower base and acrylic white walls available to suite

## COLOUR:

Polished chrome

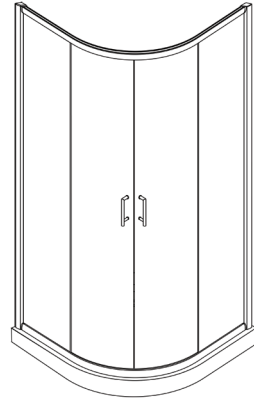

# KORTINA SLIDING SHOWER SCREEN

## FEATURES:

- Frameless sliding shower
- Architectural elegance
- Left or right hand entry available
- Easy to install 20mm adjustment on walls
- Front only or front and return configurations
- Suitable for placing on tiles or a base
- Designed without gaps, no water leaking
- 10 mm toughened safety glass

## SPECIFICATIONS:

Sizes: 1900mm Height  
Front Door 1140mm - 1500mm  
Polished chrome  
Custom matte black

FRONT ONLY  
Right hand

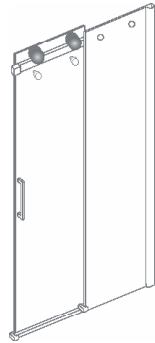

FRONT AND RETURN  
Left hand

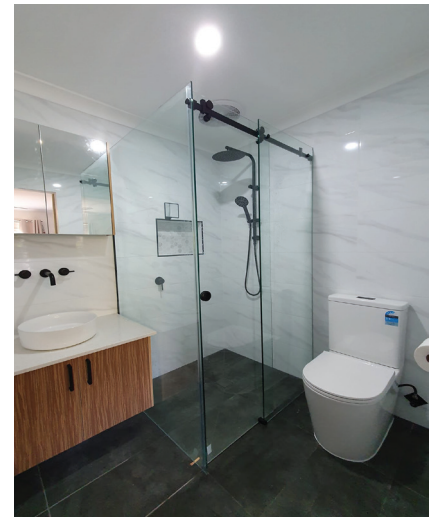
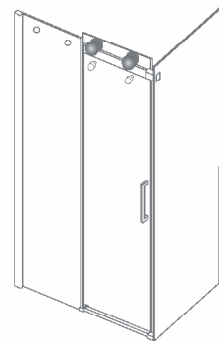

# LONDON BOX SLIDING SCREEN

## FEATURES & BENEFITS:

- Urban gliding Corner Shower screen
- Space saving shower
- Easy gliding corner opening two panels
- Polished chrome finish
- Easy to install configuration
- Magnetic closure strip on the door
- Suitable for placing on tiles or a base

## SPECIFICATIONS:

Sizes:  
845-870 x 845-870  
(suitable for a 900x900 tray)  
1900mm Height  
Chrome

880-905 x 880 x 905  
2000mm Height  
Chrome

880 - 905 x 880 - 905  
1900mm Height  
Matte Black

## COLOUR:

Polished chrome  
Matte Black

## TECHNICAL:

- Adjustable on wall channels
- Magnetic closure strip on the door
- 6mm toughened safety glass



# CUSTOM PIVOT

## FEATURES & BENEFITS:

- Semi-frameless pivot shower
- Clear safety glass
- Suitable for placing on tiles or base
- Toughened safety glass

## SPECIFICATIONS:

Sizes are custom made

## COLOUR:

Polished Chrome  
Matte Black  
Other Available



# CUSTOM SLIDING

## FEATURES & BENEFITS:

- Semi-frameless sliding shower
- Gliding action
- Clear safety glass
- Adjustment 20mm on the wall channels
- Suitable for placing on tiles or base
- Toughened safety glass

## SPECIFICATIONS:

Sizes:  
Custom Made

## COLOUR:

Polished Chrome  
Matte Black  
Other Available



# HALF - MOON WALK-IN

- Semi-circle walk-in shower
- Towel rail on outer glass
- Clear safety glass
- Frameless fixed panels
- Adjustment 20mm on the wall channels
- Suitable for placing on tiles
- Toughened safety glass

1850mm Height  
1200mm Width (can vary on tiles)





# CUSTOM SHOWERS

Designs custom made to suit functionality, design & budget.



10mm low-iron narrow-reef glass with brushed brass hardware - project completed by Pipers expert install team.

# BENTLI SHOWER SCREEN

## FEATURES:

- Pipers Smart Shower Hinge is adaptable, flexible and plays an active role in the success of your frameless shower screen projects
- Frameless pivot door
- Clear safety glass
- Fully reversible for left or right hand entry
- Amazing 70mm Adjustment
- Several configurations and sizes available
- Suitable for placing on tiles or a base
- Complete your shower in one simple install

## SPECIFICATIONS:

Sizes:  
10mm toughened glass AS/NZS 2208  
Suitable for:  
"900 trays"  
Adjustable front 850 - 920 x 850  
"1200trays"  
Adjustable front 1150 - 1220 x 850  
Or tiled areas.

## COLOUR:

Polished chrome

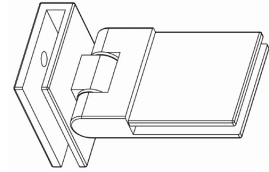

## INTRODUCING A NEW CLASS OF FRAMELESS



# BATH SCREENS

## FIX AND SWING

- DIY easy installation
- Clear Safety Glass
- Frameless rounded edge
- Slimline chrome frame
- Ability to swing in or out
- Optional bracing for stability
- Low maintenance design easy to clean
- 6 mm toughened safety glass

## SPECIFICATIONS:

Sizes:  
1500mm Height  
1000mm Wide  
(500mm fixed 500mm swing)

## COLOUR:

Polished chrome  
Matte black



## MISO BATH SCREEN

- Frameless Rounded polished Edge
- Swinging glass panel
- Slimline Contemporary wall channel
- Easy installation
- 6 mm toughened clear safety glass

## SPECIFICATIONS:

Sizes:  
1500mm Height x 800mm Wide

## COLOUR:

Polished chrome



## BON BATH SCREEN

- Frameless fixed bath panel
- Adjustable chrome wall channel
- Easy installation
- 10mm toughened clear safety glass

## SPECIFICATIONS:

Sizes:  
1500mm Height x 800mm Wide

## COLOUR:

Polished chrome



# FREE-STANDING FRAMELESS SHOWER SCREEN

- Distinguished double entry shower design
- Frameless minimalist feature
- Large variety of sizes available
- Chrome overhead support braces
- Pipers signature chrome brackets
- Clear 10mm toughened safety glass



# FRAMELESS WALK IN DOUBLE PANELS

Pipers simple yet inspired Eco Double Walk-In shower ticks all the boxes for a modern home.

**Design Feature.** A truly elegant design feature in your bathroom with the luxury of two shower heads. Featuring chrome plated brass fixings or an aluminium channel.

It's no secret that a well designed bathroom with a Frameless shower adds value to your house price tag. Installing a double walk in shower screen gives you great value for money.

Pipers Eco Double Walk in Shower is Inspired by a vibrant cultural city of Melbourne for people balancing a busy lifestyle. All Pipers Shower Screen glass is toughened to Australian Standards AS/NZS 2208:1996



# CUSTOM MIRRORS

## PIPERS STYLISH POLISHED EDGED OR FRAMED MIRRORS

Pipers mirrors are made to your specifications available in all sizes.

Pipers mirrors are a classic addition to place on top of the bathroom vanity – made to measure on the wall, or as an addition to open up a small space. There are multiple uses for mirror unlimited by your imagination!

Use mirrors to bounce off light.  
Expansive mirror over the vanity increases depth of space.

## SPECIFICATIONS:

Custom mirror is available in 4mm and 6mm thickness.

Round Polished edge mirrors also available.

Allow 2-3 days manufacturing lead times.



# ROUND BRUSHED BRASS MIRROR



## SPECIFICATIONS:

Brushed Brass Metal Circular Frame

Round Polished edge silvered mirror  
Available in popular sizes:

600mm  
700mm  
800mm  
900mm

Round Polished Edge Custom made mirrors also available.

# ROUND MATTE BLACK MIRRORS

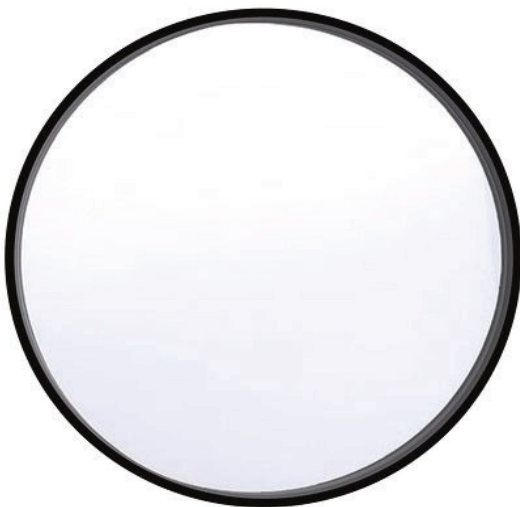

## SPECIFICATIONS:

BLACK Metal Circular Frame

Round Polished edge silvered mirror  
Available in popular sizes:

500mm  
600mm  
700mm  
800mm  
900mm  
1000mm  
1200mm

Round Polished Edge Custom made mirrors also available.

NEW OVAL AND ARCH MIRROR  
DESIGN NOW AVAILABLE!

# HARDWARE & SHELVING

DURABLE & CONTEMPORARY

Pipers brass hardware manufactured to the highest grade, suitable for 10mm shower screens.

## HINGES



H-GG180 SQ C 180°  
Glass to Glass Square  
Shower Hinge



H-GW90 SQ C 90°  
Glass to Wall  
T Shape Hinge



H-GW90L SQ C 90°  
Glass to Wall Hinge  
L Shape (3 holes)



H-GW90LEX SQ C 90°  
Glass to Wall Hinge  
L Shape (4 holes)



H-GG90 SQ C 90°  
Glass to Glass Square  
Shower Hinge



H-GG135 SQ C 135°  
Glass to Glass Square  
Shower Hinge

## ALUMINIUM



H-GWBK1  
50 x 50mm Glass-Wall  
Bracket (Square)



H-GGBK2  
50 x 50mm Glass to  
Glass Bracket (Square)

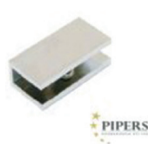

H-GFB10 SQ  
Glass Fix Bracket for  
10mm Glass (Square)



H-GFB10 RD  
Glass shelf bracket  
circular for 10mm Glass



H-GCH-10  
Aluminium Glazing



H-ADSL1  
12mm\*6mm Polished  
Chrome Dome Door Seal

## HANDLES



H-KHRD  
Shower Door Knob



H-KHSQ  
Shower Door Square



H-DPH2H  
Shower large double  
pull handle square



H-STDKB  
Short knob handle



ELFREDA SUITE  
HANDLE



H-QCGS200 10mm  
glass Quarter Circle  
Glass Shelf



H-QCGS250 10mm  
glass Quarter Circle  
Glass Shelf



H-RGS600 10mm glass  
600mm Rectagular  
Glass Shelf



H-RGS900 10mm glass  
900mm Rectagular  
Glass Shelf



H-RGS300 10mm glass  
300mm Rectagular  
Glass Shelf



H-WS-1  
Water seal  
10mm for side of door



H-WS-6MM-10  
Shower Door  
Water Seal 6mm



H-WS-10MM  
10mm for under door



H-WS-5-6MM  
6mm water seal



H-WS-M1-10MM  
10mm 90°  
magnetic water seal



H-WSM2-10MM  
10mm 180°  
magnetic water seal



# HARDWARE & SUPPORT BARS

## SUPPORT BARS FOR FRAMELESS 10MM GLASS

To ensure stability and safe performance of frameless shower screens, glass gussets, braces and supports at the head of the frameless glass may be necessary. Pipers Standard Frameless enclosure kits have a complimentary glass gusset,



H-SB10-800-SQ  
Glass to Wall 90°  
19mm\*800mm



H-SB10-900-SQ  
Glass to Wall 90°  
19mm\*900mm



H-SB10-1000-SQ  
Glass to Wall 90°  
19mm\*1000mm



H-SB17-900-SQ  
Glass to Wall, 90° back  
900MM



H-SB16-900-SQ  
Glass to Wall 45°  
900mm



H-SB12-800-1200-GW  
Glass to Wall  
800-1200mm Adjustable



H-SB13-600-800-GG  
Glass to Glass 45° splade  
600-800mm Adjustable



H-SB14-800-1200-GW  
Glass to Wall 90°  
800-1200mm Adjustable

## BENTLI HARDWARE



BENTLI HANDLE



H-GG-SMT-A  
Smart Shower Hinge

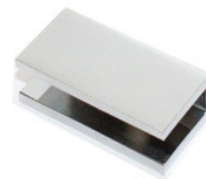

H-GFB10 SQ  
Glass Fix Bracket for 10mm  
Glass (Square)

MORE AVAILABLE ON OUR  
WEBSITE OR CALL 1300 005 384



H-MB10 SQ  
Glass Fix Bracket for 10mm  
Glass (Square)



H-KH-MB RD  
Knob Handle



H-GG180 MB  
180 degree Hinge

CHROME  
MATTE BLACK  
BRUSHED NICKLE  
BRUSHED BRASS  
GUN METAL GREY  
GOLD  
WHITE  
AVAILABLE

TO ENQUIRE OR ORDER:

Call 1300 005 384, or visit [www.pipersinternational.com.au](http://www.pipersinternational.com.au) or email details to [info@pipersinternational.com.au](mailto:info@pipersinternational.com.au)

Drawings and plans can be emailed to [info@pipersinternational.com.au](mailto:info@pipersinternational.com.au)

It's in the interest of first time shower screen buyers to make sure they are familiar with the basic features and functionalities. There are many styles and designs, each one performing and looking differently.

PIPERS trained professionals can share their experience and give you the best advice for your project. All of our showers have undertaken research and development, we take pride in our product design and look forward to starting your project!

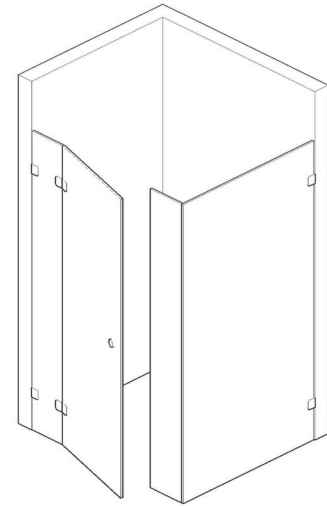

NOTES

Five horizontal lines for writing notes.

To view our extended range of products visit [www.pipersinternational.com.au](http://www.pipersinternational.com.au)

Please note:

- 1. There is no refund or exchange on items that are custom made, or unpacked or installed.
- 2. Please take care in providing measurements and choosing your products carefully. PIPERS will not accept any responsibility for incorrect measurements or specifications by the client.
- 3. Please choose your style carefully & understand the products specifications i.e. some frameless showers are known to leak due to the required gap in the door or if your shower rose is facing it.

Disclaimer

PIPERS International reserve the right to amend products and services outlined, check our website for current information.

PIPERS INTERNATIONAL

Visit us on:



Address

38 Jesica Rd  
Campbellfield Vic 3061

Tel

1300 005 384

Email

[info@piperinternational.com.au](mailto:info@piperinternational.com.au)

[PIPERSINTERNATIONAL.COM.AU](http://PIPERSINTERNATIONAL.COM.AU)

