

# **INSTALLATION INSTRUCTIONS**

## **ELFREDA SUITE SERIES 3**

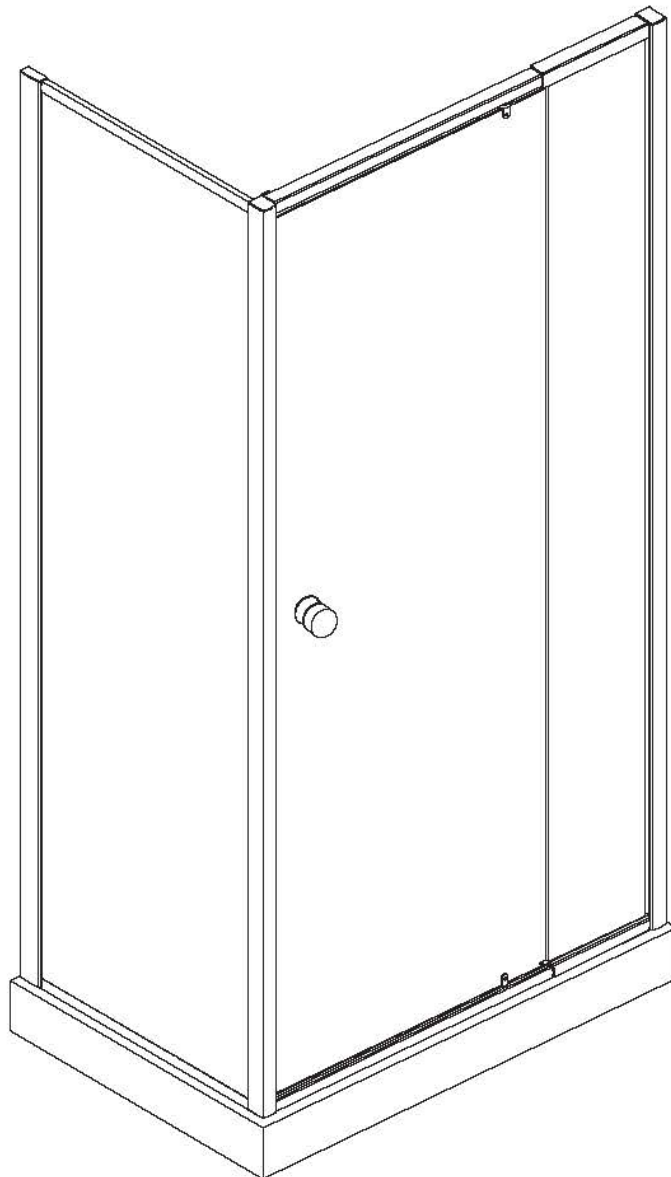

## ◆ General Information

Please inspect the product immediately upon receipt for transit damage, missing packs/parts or manufacturing fault. Damage reported later cannot be accepted. Please handle the product with care avoiding knocks and shock loading to all sides and edges of the glass.

**Notes: Safety glass can not be re-worked.**

Please read these instructions carefully before start of installation.

Special care should be taken when drilling walls to avoid hidden pipes or electrical cables.

Note: This product is heavy and may require two people to install.

## Aftercare instructions

After use, your shower should be cleaned with soap and water. This is particularly important in hard water districts where insoluble lime salts may be deposited and allowed to build up.

Cleaners of a gritty or abrasive nature should not be used. Care should be taken to avoid contact with strong chemicals such as organic solvents and strippers.

Glass cleaners can be used but with caution, if in doubt contact the manufacturer of the cleaner in question.

Please keep these instructions for aftercare and customer service details.

---



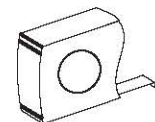
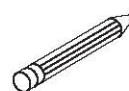
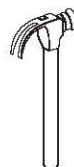
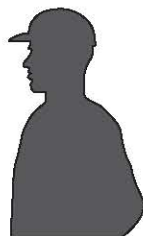
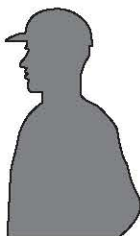
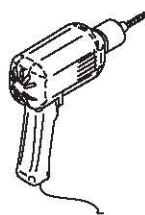
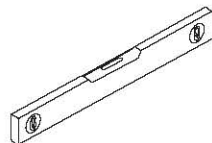
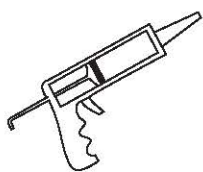



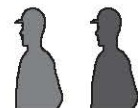

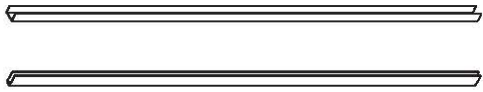

## Tools Required



**This product is heavy and may require two people to install.**

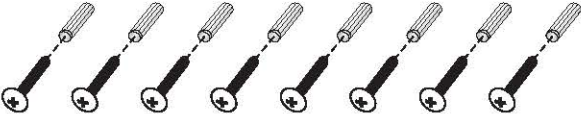

## ◆ Packing List (Door Panel)

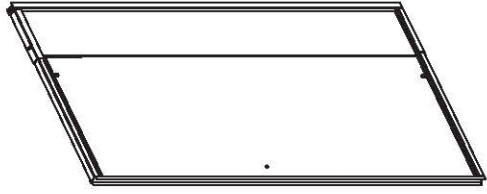
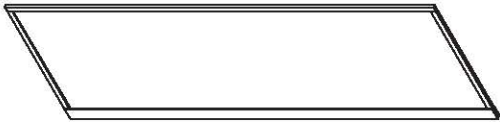
<p>[1] 2xWall Posts</p>	<p>➔</p>		
<p>[2] 1xCorner Post</p>	<p>➔</p>		
<p>[3] 1xInstallation Instruction</p>	<p>➔</p>		
<p>[4] 1xHandle Set</p>	<p>➔</p>		
<p>[5] 3xProfile Covers</p>	<p>➔</p>		
<p>[6] 8xWall Plugs 8xFlat Screws M4x35</p>	<p>➔</p>		
<p>[7] 12xScrews M4x8 12xScrew Cover Caps</p>	<p>➔</p>		
<p>[8] 6xScrews M4x12 2xScrew Cover Caps</p>	<p>➔</p>		
<p>[9] 2xWater Deflectors</p>	<p>➔</p>		
<p>[10] 1xDoor Panel+ Fixed Panel</p>	<p>➔</p>		
<p>[11] 1xFixed Panel</p>	<p>➔</p>		

# ◆ Assembly Drawing

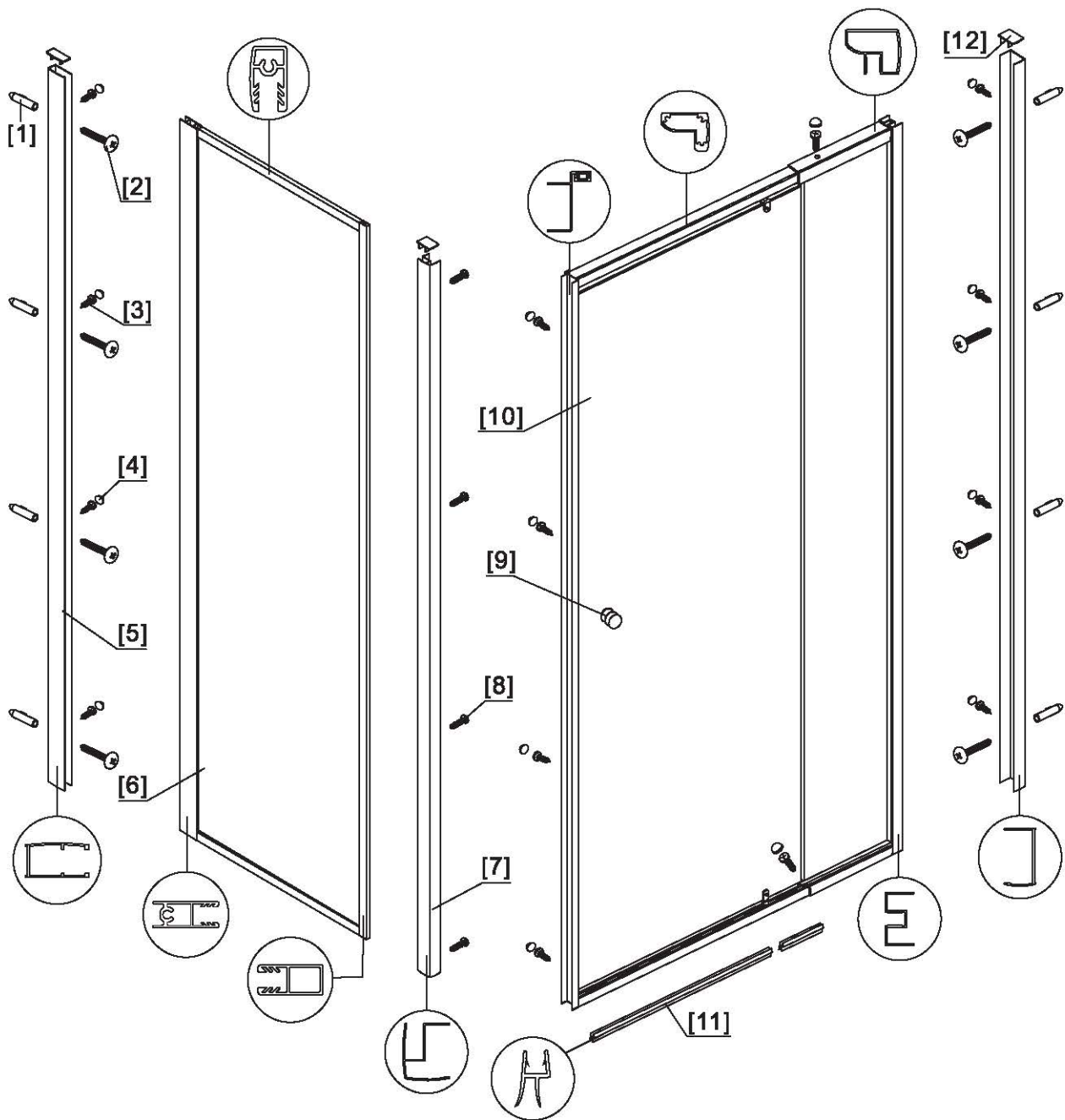

- [1] 8xWall Plugs
- [2] 8xFlat Screws M4x35
- [3] 12xScrews M4x8
- [4] 14xScrew Cover Caps
- [5] 2xWall Posts
- [6] 1xFixed Panel

- [7] 1xCorner Post
- [8] 6xScrews M4x12
- [9] 1xHandle Set
- [10] 1xDoor Panel+Fixed Panel
- [11] 2xWater Deflectors
- [12] 3xProfile Covers

# ◆ Installation Steps:

## Step 1

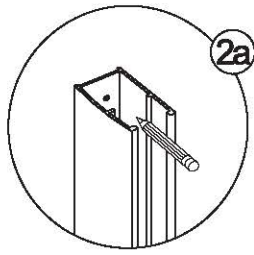

2a

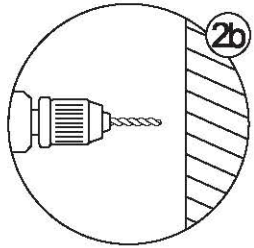

2b

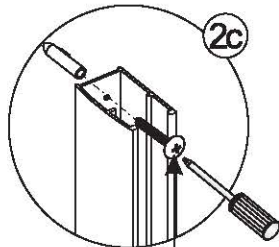

2c

Flat Screw  
M4x35

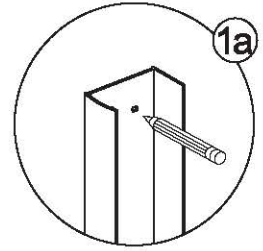
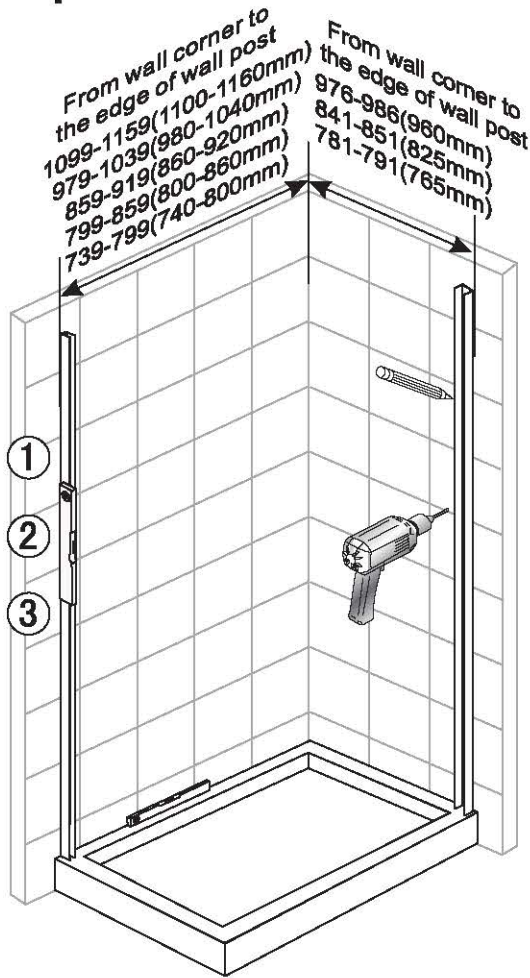

1a

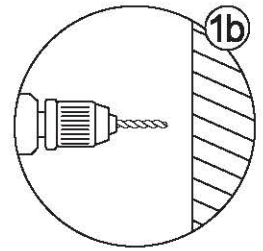

1b

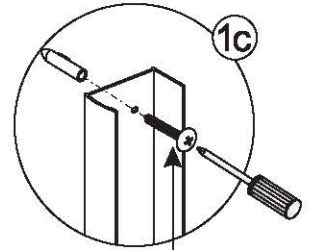

1c

Flat Screw  
M4x35

## Step 2

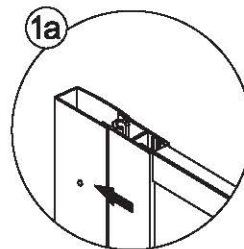
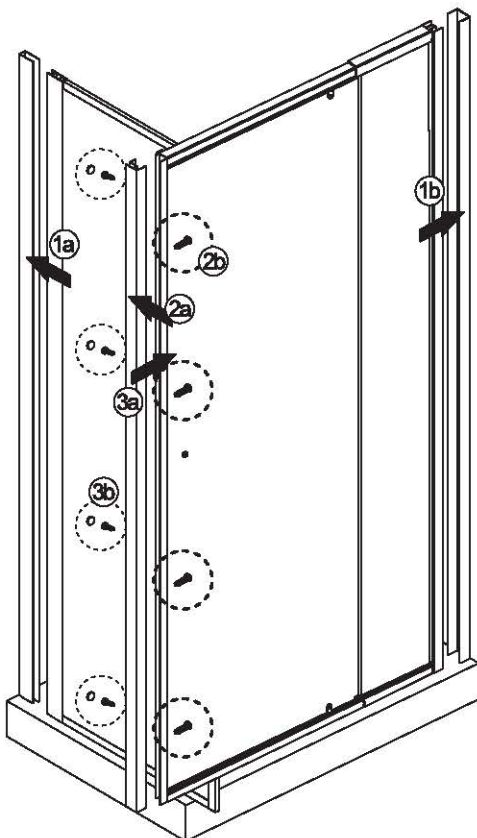

1a

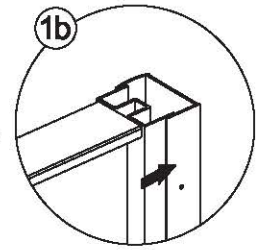

1b

View from inside

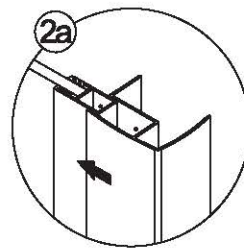

2a

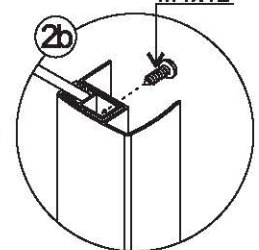

2b

Screw  
M4x12

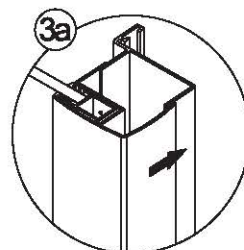

3a

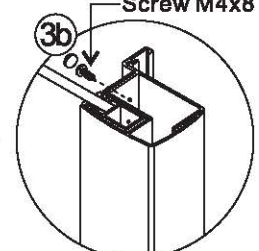

3b

Screw M4x8



### Step 3

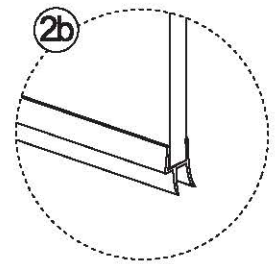
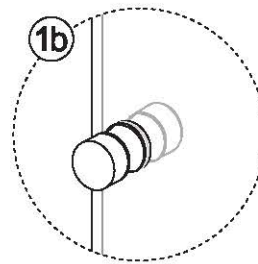
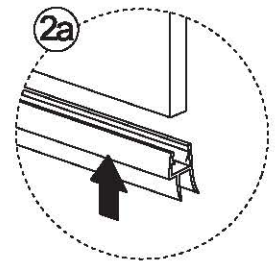
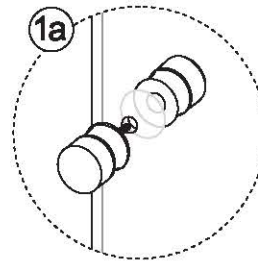
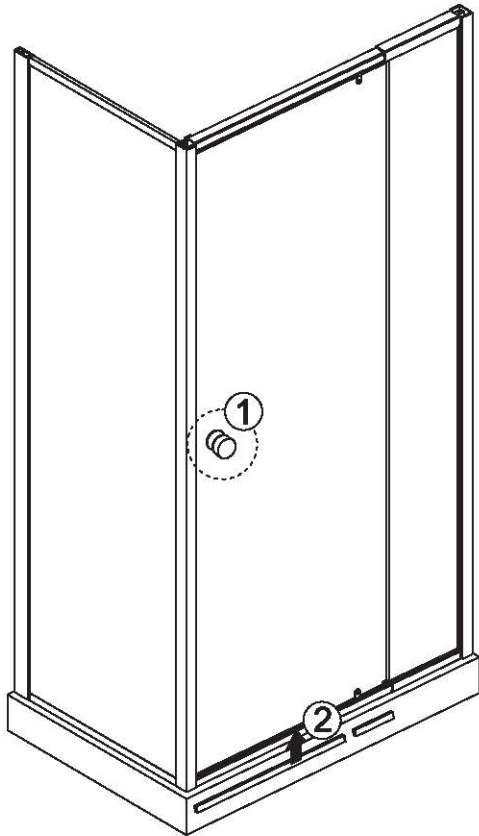

### Step 4

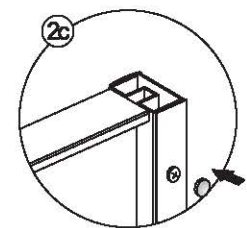
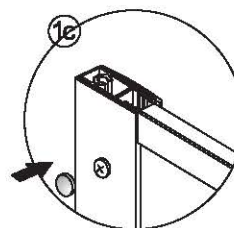
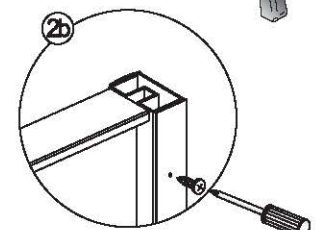
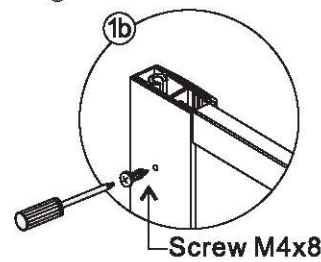
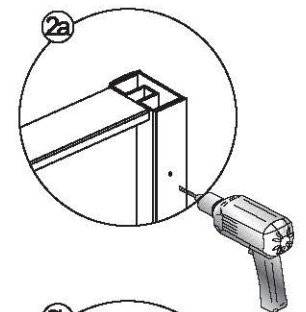
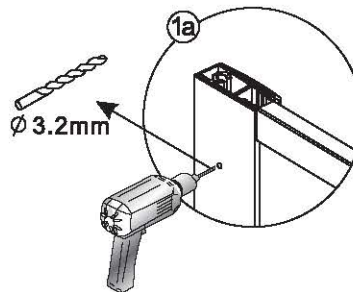
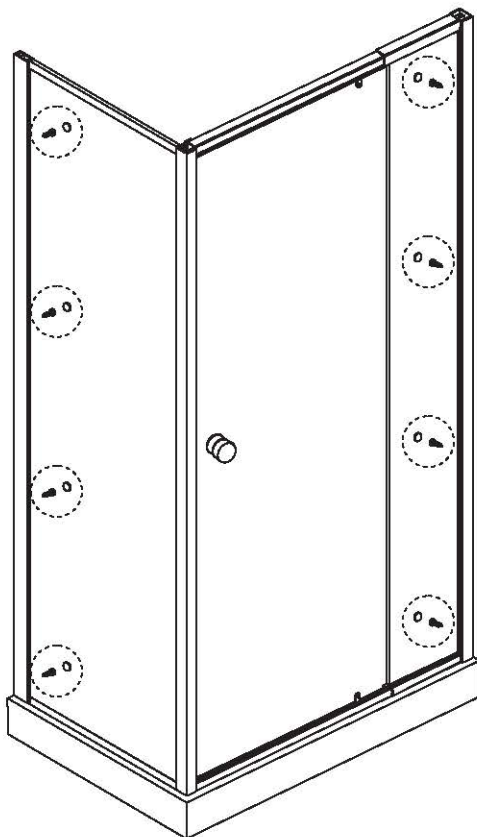

View from inside

## Step 5

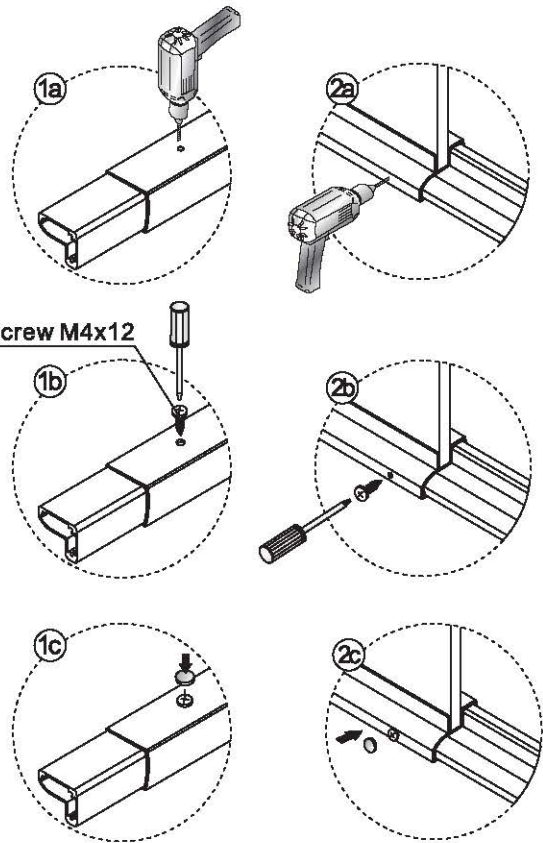
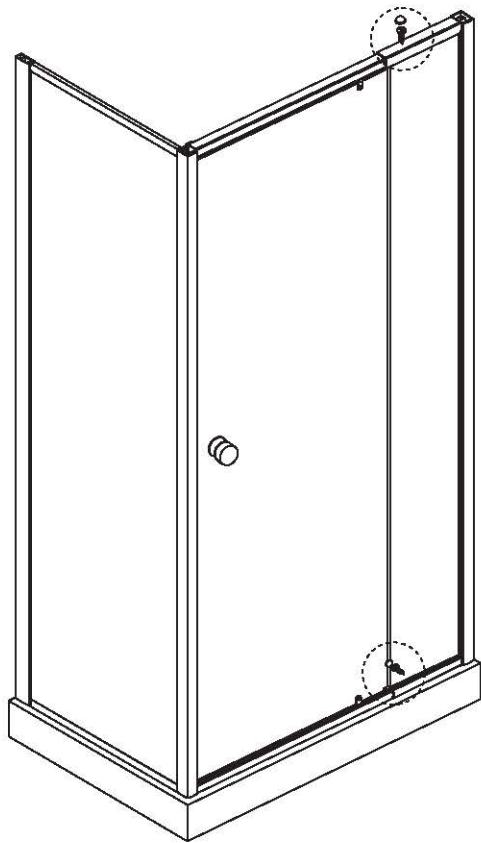

Screw M4x12

View from inside

## Step 6

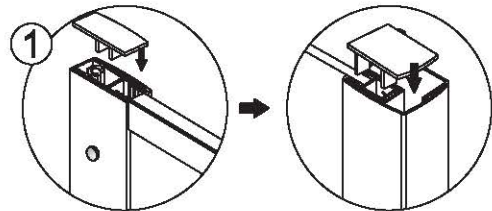
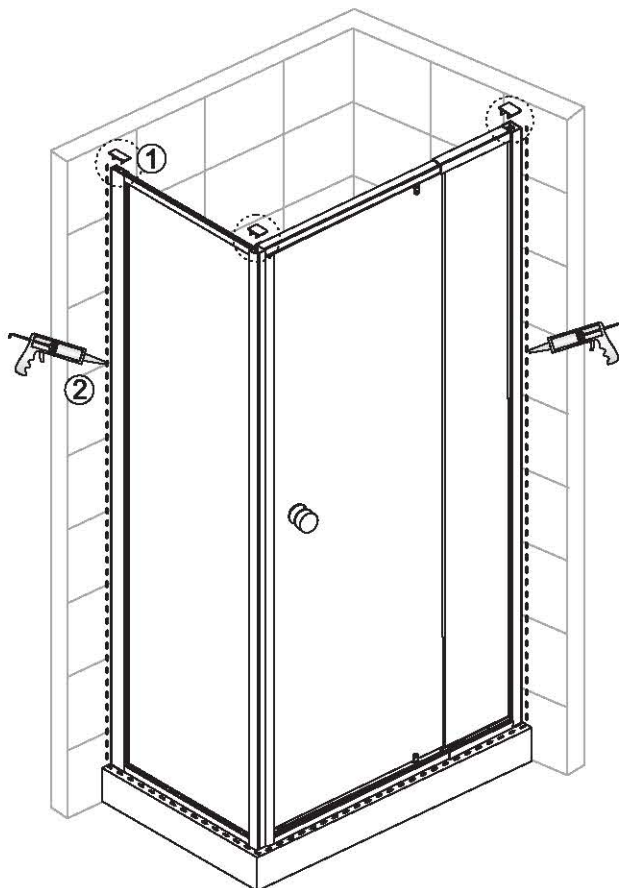

View from inside



Allow 24 hours for silicone to dry before use.